

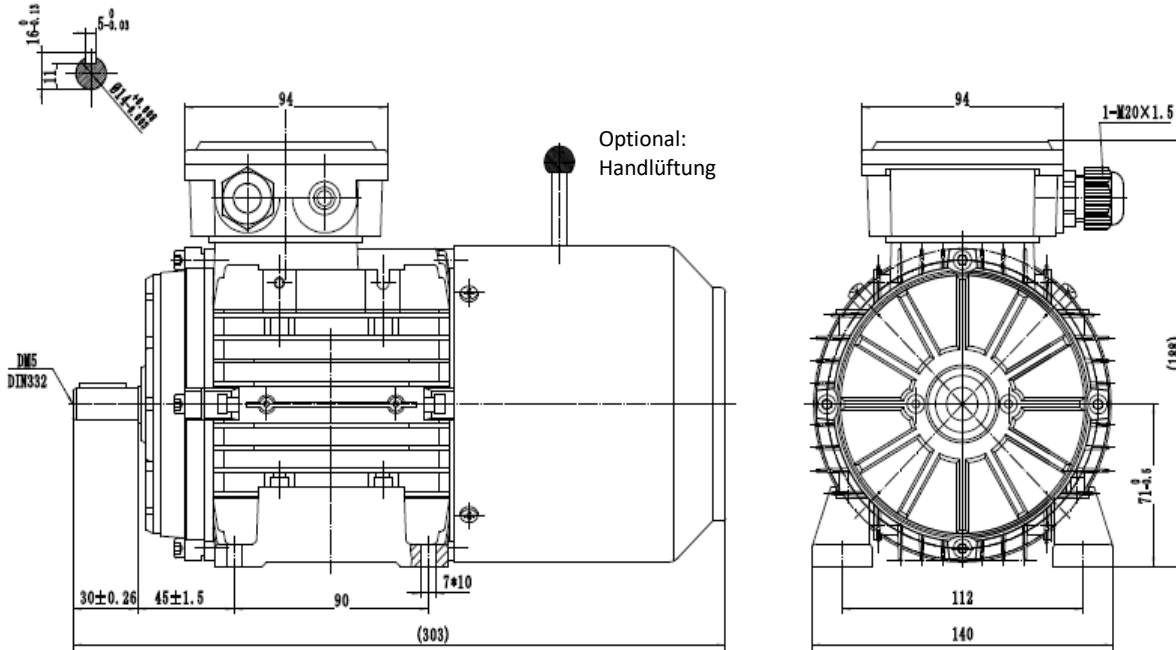

Drehstrombremsmotor / Three-Phase-Brakemotor
IE3 - 0,25 kW - 6 polig / 6 pole B3



Typ / type **SEV-BM3 712-6**

Gehäusematerial / frame material		Aluminum	Nenn Drehmoment / rated torque	2,60
Ausführung / execution		Dreiphasen/ three phase	Anzugs- zu Nennmoment / start- to rated torque	2,2
Baugröße / frame size		71	Kipp- zu Nennmoment / brakedown- to rated torque	2,5
Leistung / power @50Hz	kW	0,25	min. Dreh- zu Nennmoment / min- to rated torque	2,2
Nennstrom / rated current @230V	Δ	1,40	Anzugs- zu Nennstrom / starting- to rated current	3,7
Nennstrom / rated current @400V	Y	0,81	Lager / bearing (DE)	6202-2RZ
Drehzahl / speed @50Hz	(r/min)	920	Lager / bearing (NDE)	6202-2RZ
Wirkungsgrad / efficiency	IE3		Wellendichtung / shaft seal (DE/NDE)	15x25x7
	Eff. 100%	68,60	Hauptkabelverschraubung / main cable glands	1-M20*1.5
	Eff. 75%	67,20	Isolationsklasse / insulation class	F
	Eff. 50%	61,20	Schutzart / protection degree	IP 55
Leistungsfaktor / power factor cosφ	100% load	0,65	Thermischer Schutz / thermal protection	3*PTC
60Hz 265/460V	Power(kW)	0,29	Drehrichtung / rotation direction	rechts-links / clockwise-counterclockwise
60Hz 276/480V	Power(kW)	0,30	Einschaltdauer / service duty	S1
Drehzahl / speed @60Hz	(r/min)	1105	Wuchtung / balance	Halbkeilwuchtung / half-key balanced
Ausführung Bremse / execution brake		BLC457-06	Kühlungsart / cooling	IC 411
Bremsmoment / braking torque (@ 100 Upm / rpm)		6	Lautstärke / noise dB(A)	52
Normen / regulations		IEC / DIN / ISO / VDE / EN	Nettogewicht / net weight(kg)	8,05
Standard / standard		IEC 60034	Massenträgheitsmoment / moment of inertia (kg*m ²)	0,001020000
Umgebungstemperatur / ambient Temp.		-20°C ~ +40°C	Aufstellungshöhe / altitude (max.)	1000m über Meeresspiegel / above sea level